

EVO-AN-SLZ-40W SERIES

Specification

Power	40W
LED	96pcs
Luminous Flux	210 lm/w
LiFePO4 Battery	12.8V/28AH
Mono Solar Panel	18V65W
Solar Charging Time	6 - 8 hours by bright sunlight
Lighting Time In Rainy Day	7 - 10 days
Lighting Mode	12 hrs motion sensor control (Bright lighting 30 secs when people move through the light) + Remote Controller
PIR	120°C, >8m
Material	Aluminium alloy + PMMA
IP/IK Class	IP66 / IK 10
Operating Temperature	-25°C to 65°C
Dimension	848.60 x 385.50 x 139.00mm

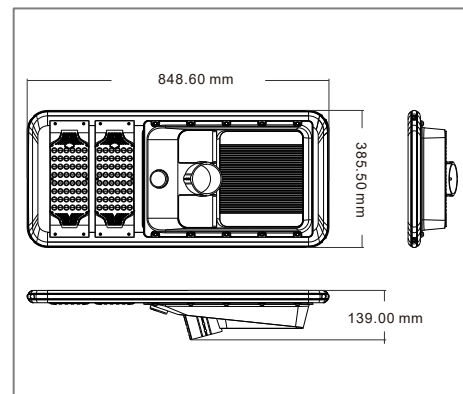

Features

- Mainstream Integrated Structure Design
Saving transportation cost. Easy to install and convenient for maintenance.
- Die-cast Aluminum Bracket
High mechanical strength, anti-wind resistance of Level-16.
- High Power
Enlarged capacity LED module design, equipped with high-brightness. Bridgelux LED chips, improving the brightness by 30%.
- Remote Control
Three lighting modes for choice, flexible to switch via remote control.
- LifePo4 Battery
Brand new and big capacity
- Mono Solar Panel
22% photoelectric conversion efficiency
- PIR Sensor
More than 8m sensing distance

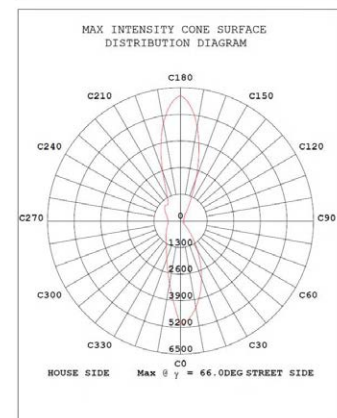
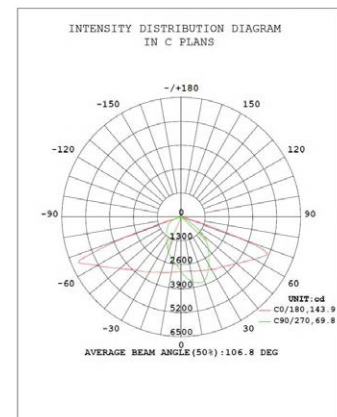

* Product specification subject to change according to technology improvement.